

HENDERSON SINGLE TOP

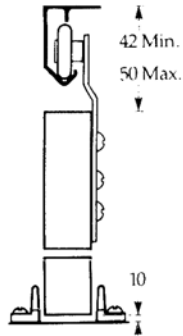

12ST A=600 mm 45 kg
 15ST A=750 mm 45 kg
 18ST A=900 mm 45 kg

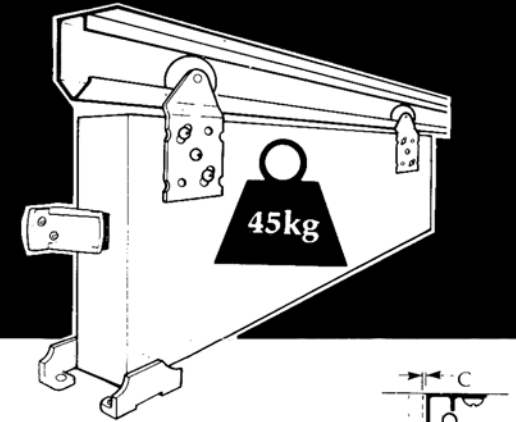
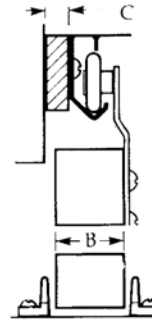

B	16	19	22	25	29	32	35	38	40
C	—	—	2	5	9	12	15	18	20

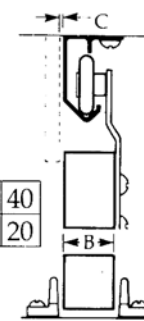

1

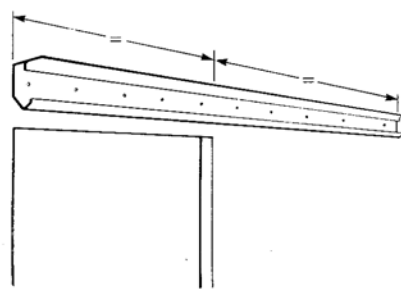

2

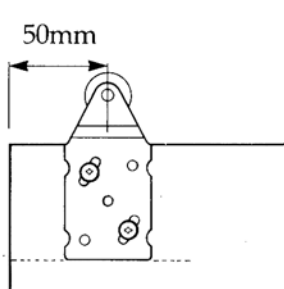

3

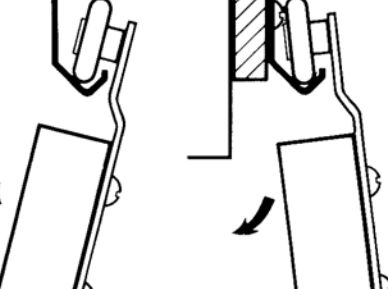

4

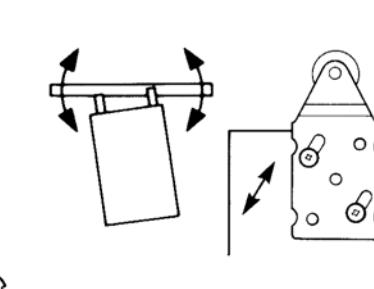

5

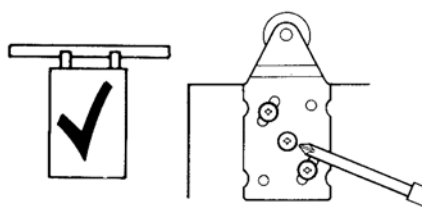

6

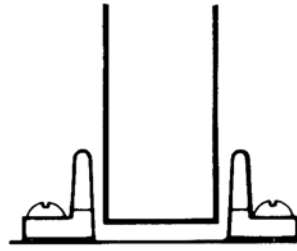

7

